

REV	ECN NO	DESCRIPTION	DATE	APPD
A		NEW	2011.01.27	黄文琛

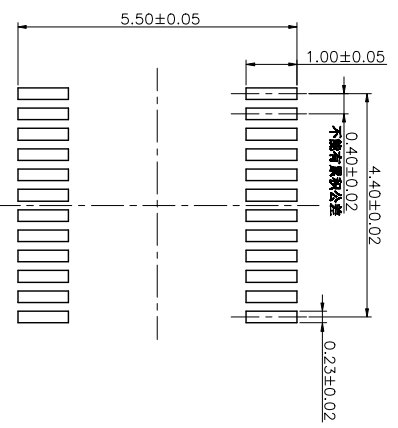

RECOMMENDED PCB LAYOUT
TOP VIEW (TOLERANCE:±0.05)

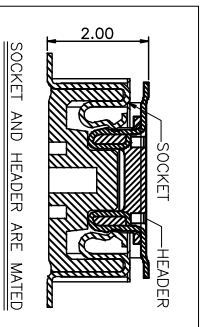
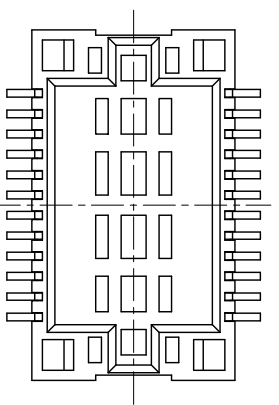
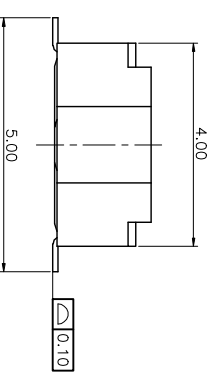
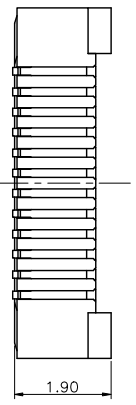
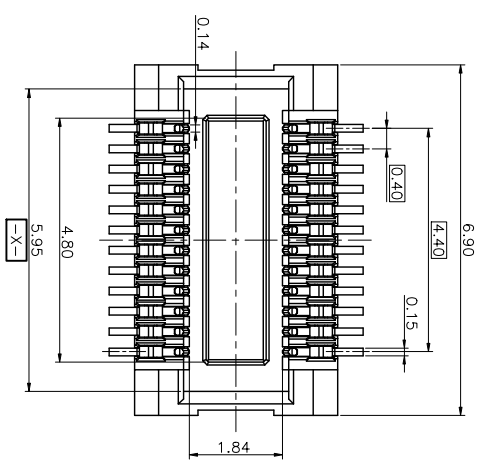
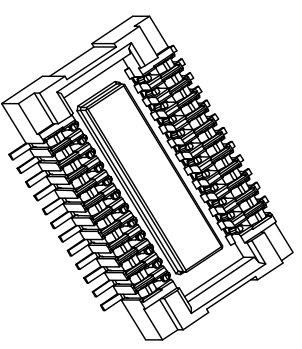

EXTEND USE		TITLE		DWG NO	
0.4 BTB 2.0H F-CONN	UNIT	0.4 BTB 2.0H F-CONN	CUSTOMER DRAWING	C-5017A0	
GENERAL TOLERANCE	mm	MATERIAL	APPD	P/N:	
DIMENSION	ANGLES	QTY	FINISHED	DRN	
±0.20	±2°			黄文琛	
±0.15	±1°			2011.01.27	
±0.10	±0.5°				
±0.05					
SHEET SCALE		SHEET		REV	
1/1		1/1		A	

- 说明:**
- NOTE:
1. 塑胶材料: 热塑性塑胶, 颜色: 黑色;
HOUSING MATERIAL: THERMOPLASTIC, COLOR: BLACK;
 2. 端子材料: 铜合金;
CONTACT MATERIAL: COPPER ALLOY;
 3. 产品性能:
PERFORMANCE:
3.1. 接触阻抗: 不高于80mΩ.
CONTACT RESISTANCE: 80mΩ. Max.
3.2. 耐电压: 100V AC, 1 Minute;
DIELECTRIC WITHSTANDING VOLTAGE: 100V AC FOR 1 MINUTE;
3.3. 绝缘阻抗: 不低于1000MΩ.
INSULATION RESISTANCE: 1000MΩHM Min.
3.4. 插接耐久性: 至少50次
DURABILITY: 50TIMES Min.
 4. 料号说明:
5.017A0-024-*R0
1: 接触区15u" Au, 焊锡区1u"
2: 接触区3u" Au, 焊锡区1u"
3: 接触区5u" Au, 焊锡区1u"



A4 1 2 3 4 5 6 7 8

E D C B A

1 2 3 4 5 6 7 8